

THANK YOU FOR BUYING A WHIRLPOOL PRODUCT

In order to receive a more complete assistance, please register your product on www.whirlpool.eu/register



Before using the appliance carefully read the Safety Instruction.

Before using the machine, it is imperative that the transport bolts are removed. For more detailed instructions on how to remove them, see the Installation Guide.

CONTROL PANEL

1. On/Off button
2. Programme selector
3. Start/Pause button
4. Temperature button
5. FreshCare+ button
6. Dry Only button / Lock button
7. Drying settings button
8. Display
9. Start delay button
10. Spin speed button

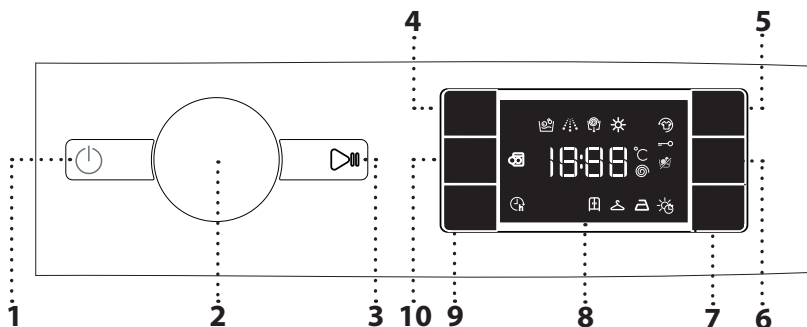

DISPLAY INDICATORS

- Washing phase** Indicates washing phase of the cycle
- Drying phase**
- FreshCare+ activated**
- Key lock activated**
- Drying only**
- Timer drying mode**
- Drying automatic levels**
- Start delay activated**
- Door locked**

WASH CYCLE TABLE

Programme		Temperatures		Max. spin speed (rpm)	Dry-ing	Max. load for wash cycle (kg)	Max. load for drying cycle (kg)	Duration (h : m)	Detergents and additives			Recommended detergent		Residual dampness % (***)	Energy consumption kWh	Total water lt	Laundry temperature °C
		Setting	Range						Prewash	Main	Softener	Powder	Liquid				
									1	2	3						
	MIXED	40°C	☀ - 40°C	1000	✓	4,5	4,5	**	-	●	○	-	✓	-	-	-	-
	COTTON (2)	60°C	☀ - 60°C	1400	✓	9,0	6,0	3:55	-	●	○	✓	✓	49	1,1	95	40
	SYNTHETICS (3)	60°C	☀ - 60°C	1200	✓	4	4	2:55	-	●	○	✓	✓	35	0,75	55	43
	RAPID 30'	30°C	☀ - 30°C	800	-	4,5	4,5	0:30	-	●	○	-	✓	71	0,2	45	27
	20°C	20 °C	☀ - 20 °C	1400	✓	9,0	6,0	1:50	-	●	○	-	✓	49	0,16	90	22
	WASH & DRY 45'	30°C	30°C	1400	✓	1,0	1,0	**	-	●	○	-	✓	-	-	-	-
	WASH & DRY 90'	30°C	30°C	1200	✓	2,0	2,0	**	-	●	○	-	✓	-	-	-	-
	SPIN & DRAIN *	-	-	1400	✓	9,0	6,0	**	-	-	-	-	-	-	-	-	-
	RINSE & SPIN	-	-	1400	✓	9,0	6,0	**	-	-	○	-	-	-	-	-	-
	WHITE	90°C	☀ - 90°C	1400	✓	9,0	6,0	2:45	● (90°)	●	○	✓	✓	49	0,9	90	55
	ECO 40-60 (1)	40 °C	40°C	1351	✓	9,0	6,0	3:40	-	●	○	✓	✓	53,5	0,86	54	38
				1351	✓	4,5		2:50	-	●	○	✓	✓	53,5	0,68	54	37
				1351	✓	2,25		2:10	-	●	○	✓	✓	53,5	0,46	40	34
	WOOL	40°C	☀ - 40°C	800	✓	2,0	2,0	**	-	●	○	-	✓	-	-	-	-
	DELICATES	30°C	☀ - 30°C	0	✓	1,0	1,0	**	-	●	○	-	✓	-	-	-	-
	COLOURS 15°	15°C	15°C	1000	✓	4,5	4,5	**	-	●	○	-	✓	-	-	-	-
● Required dosage ○ Optional dosage																	
	ECO COTTON (4)	60°C	60 °C	1400	✓	9,0	6,0	3:40	-	●	○	✓	✓	53	1,17	60	-

For wash programmes with temperatures above 50°C, we recommend using powder detergent rather than liquid, and following the directions given on the detergent package. This data may differ in your home due to changing conditions in inlet water temperature, water pressure etc. Approximate programme duration values refer to the default setting of the programmes, without options. The values given for programmes other than the Eco 40-60 programme are indicative only.

For all Test Institutes

1) **Eco 40-60 (Wash)**- Test wash cycle in compliance with EU Ecodesign regulation 2019/2014. The most efficient programme in terms of energy and water consumption for washing normally soiled cotton laundry.

Eco 40-60 (Drying)- Test wash cycle in compliance with EU Ecodesign regulation 2019/2014. To access "wash and dry" cycle select "Eco 40-60" wash programme and set "Drying" option level to . The most efficient programme in terms of energy and water consumption for washing and drying normally soiled cotton laundry.

Note: spin speed values shown on the display can slightly differs from the values stated in the table.

2) Long cotton programme: set the programme with a temperature of 40°C.

3) Synthetic program along: set the programme with a temperature of 40°C.

* Select the programme and set the spin speed to "0" to empty only.

** The duration of the programme is shown on the display.

*** After programme end and spinning with maximum selectable spin speed, in default programme setting.

6th Sense - the sensor technology adapts water, energy and programme duration to your wash load.

4) Eco Cotton - Test wash cycle in compliance with regulations 1061/2010. Set wash cycle at a temperature of 60°C to access this cycles.

PRODUCT DESCRIPTION

1. Worktop
2. Detergent dispenser
3. Control panel
4. Door handle
5. Door
6. Water filter
7. Adjustable feet (4)

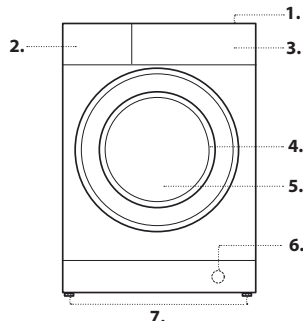

DETERGENT DISPENSER

Compartment 1: Pre-wash detergent (powder)

Compartment 2: Washing detergent (powder or liquid)

Compartment 3: Additives (fabric softeners, etc.)

The fabric softener must not exceed the "MAX" level.

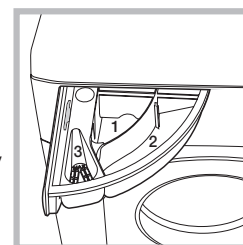

! Use powder detergent for white cotton garments, for pre-washing, and for washing at temperatures over 60°C.

! Follow the instructions given on the detergent packaging.

WASH CYCLES

Follow the instructions on the symbols of the garment's wash care label. The value indicated in the symbol is the maximum recommended temperature for washing the garment.

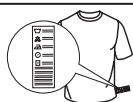

Mixed

For washing lightly to normally soiled resilient garments in cotton, linen, synthetic fibres and mixed fibres.

Cotton

for washing normally to heavily soiled towels, underwear, table and bed linen etc. in resilient cotton and linen.

Synthetics

for washing normally soiled garments made from synthetic fibres (such as polyester, polyacrylic, viscose etc.) or cotton/synthetic blends.

Rapid 30'

for washing lightly soiled garments quickly: this cycle lasts only 30 minutes, saving time and energy. Maximum load 3,5 Kg.

20 °C

For washing lightly soiled cotton garments, at a temperature of 20 °C.

Wash&Dry 45'

for washing and drying lightly soiled cotton and synthetic fibre garments quickly. This cycle washes and dries a laundry load of up to 1 Kg in just 45 minutes.

Wash & Dry 90'

for washing and drying cotton and synthetic fibre garments quickly. This cycle washes and dries a laundry load of up to 2 Kg in just 90 minutes.

Spin & Drain

spins the load then empties the water. For resilient garments.

Rinse & Spin

rinses and then spins. For resilient garments.

White

For washing normally to heavily soiled towels, underwear, table and bed linen, etc in resilient cotton and linen. Only when the temperature is selected at 90°C the cycle is provided with a prewash phase before main washing phase. In this case it is recommended to add detergent both, in the prewash and main wash section.

Eco 40-60

For washing normally soiled cotton garments declared to be washable at 40 °C or 60 °C, together in the same cycle. This is the standard cotton programme and the most efficient in terms of water and energy consumption.

Wool

All wool garments can be washed using programme, "Wool" even those carrying the "hand-wash only" label. For best results, use special detergents and **do not exceed max kg declaration of laundry**.

Delicates

for washing particularly delicate garments. Preferably turn garments inside out before washing.

Colour 15°



This cycle helps protect colours by washing in cold water (15°C) and uses less energy to heat the water while still offering satisfactory wash results. Suitable for lightly soiled, unstained garments. This cycle offers wash results comparable to 40°C mixed at just 15°C

Eco Cotton

For washing normally soiled cotton garments at 60°C.

Door locked indicator

if the  symbol is off the door is locked. To prevent any damage, wait until the symbol turns on before opening the door.



To open the door while a cycle is in progress, press the START/PAUSE button ; if the  symbol is lit, the door can be opened.

FIRST-TIME USE

Once the appliance has been installed, and before you use it for the first time, run a wash cycle with detergent and no laundry, using the wash cycle  (60°).

DAILY USE

Prepare the laundry by following the suggestions appearing under the "TIPS AND SUGGESTIONS" section.

- Press the ON/OFF button ; the START/PAUSE indicator light  will flash slowly.

- Open the door. Load the laundry while making sure not to exceed the maximum load quantity indicated in the Wash Cycle Table.

- Pull out the detergent dispenser drawer and pour the detergent into the relevant compartments as described in "DETERGENT DISPENSER DRAWER" section.

- Close the door.



- Use the WASH CYCLE selector knob to select the desired wash cycle: it will be associated with a specific temperature and spin speed that can be modified. The duration of the cycle will appear on the display.

- The machine automatically displays the default temperature and spin speed values for the selected cycle, or the most recently used settings if



they are compatible with the selected cycle.

- Select the drying cycle if desired.





- Select the desired options.

- Press the START/PAUSE  button to start the wash cycle; the relative indicator light will light up steady and the door will lock ( symbol off).

PAUSING A CYCLE

To pause the wash cycle, press the START/PAUSE  button again; the indicator light will flash. If the  symbol is lit, the door may be opened. To start the wash cycle from the point at which it was interrupted, press the START/PAUSE  button again.

OPENING THE DOOR, IF NECESSARY



Once a cycle starts, the  symbol turns off to signal that the door cannot be opened. While a wash cycle is running, the door remains locked. To open the door while a cycle is under way, for example, to add or remove garments, press the START/PAUSE  button to pause the cycle; the indicator light will flash. If the  symbol is lit, the door may be opened. Press the START/PAUSE  button again to continue the cycle.

CHANGING A RUNNING WASH CYCLE

To change a wash cycle while it is in progress, pause the washing machine using the START/PAUSE  button (the relative indicator light will flash), then select the desired cycle and press the START/PAUSE  button again.

! To cancel a cycle that has already begun, press and hold the ON/OFF  button. The cycle will be stopped and the machine will switch off.

END OF THE CYCLE

This will be indicated by the word "END" on the display; when the  symbol switches on, the door may be opened. Open the door, unload the laundry and switch off the machine. If you do not press "ON/OFF"  button, the washing machine will switch off automatically after about a 10 minutes. Close the water tap, open the door and unload the washing machine. Leave the door ajar to allow the drum to dry.

OPTIONS

! If the selected option is incompatible with the programme set, the incompatibility will be signalled by a buzzer and the corresponding indicator light will flash.

! If the selected option is incompatible with another previously set option, only the most recent selection will remain active.

Freshcare+

If associated with wash cycles, this option increases their performances by generating steam to block proliferation of the main sources of unpleasant odours inside the appliance (exclusively for the wash). After the steam phase, the machine runs a delicate cycle with slow drum rotations. When the Freshcare+ option is associated with drying cycles, it prevents stubborn creases from stabilising on garments, thanks to slow drum rotations.

The FreshCare+ cycle starts at the end of the wash or drying cycle and continues for maximum 6 hours; it can be interrupted at any time by pressing any button on the control panel, or by turning the knob. Wait roughly 5 minutes before opening the door.

Start Delay

To set the selected programme to start at a later time, press the button to set the desired delay time. The  symbol lights on the display when this function is enabled. To cancel the delayed start, press the button again until the value "0" is shown on the display.

Temperature

Each wash cycle has a pre-defined temperature. To modify the temperature, press the "Temp." button. The value will appear on the display.

Spin

Each wash cycle has a pre-defined spin speed. To modify the spin speed, press the "Spin speed" button. The value will appear on the display.

Setting the drying cycle

The first time the button "Drying settings" is pressed, the machine will automatically select the maximum drying cycle which is compatible with the selected wash cycle. Subsequent presses will decrease the drying level and then the drying time, until the cycle is excluded completely ("OFF"). Drying may be set as follows:

A- Based on the desired laundry dryness level:

Cupboard : suitable for laundry which can be put back in a cupboard without being ironed.

Hanger : ideal for clothes which do not need to be dried fully.

Iron : suitable for clothes which will need ironing afterwards. the remaining dampness softens creases, making them easier to remove.

B- Based on a set time period: between **210** and **30** minutes.

If your laundry load to be washed and dried is much greater than the maximum stated load (see adjacent table of wash cycles), perform the wash cycle, and when the cycle is complete, divide the garments into groups and put some of them back in the drum.

At this point, follow the instructions provided for a "Drying only" cycle. Repeat this procedure for the remainder of the load. Note: a cooling-down period is always added to the end of each drying cycle.

Drying only

Press button **"Dry only"** to perform the drying-only cycle. After selecting the desired cycle (compatible with the type of garments), press button **"Dry only"** to exclude the washing phase and start the drying phase at the maximum level for the selected cycle. The drying level or time may be set and changed by pressing the drying button **"Drying settings"**.

CHILD LOCK —○

to lock the control panel, press and hold the button **"Dry only"** for approximately 3 seconds. the symbol —○ lights on the display to indicate that the control panel is locked (with the exception of the  button). This prevents unintentional changes to programmes, especially with children near the machine.

If any attempt is made to use the control panel, the symbol —○ flashes on the display.

To unlock the control panel, press and hold the button **"Dry only"** for approximately 3 seconds.

TIPS AND SUGGESTIONS

Divide the laundry according to:

Type of fabric (cotton, mixed fibres, synthetics, wool, garments to be hand-washed). Colour (separate coloured garments from whites, wash new coloured garments separately). Delicates (small garments – such as nylon stockings – and items with hooks – such as bras: insert them in a fabric bag).

Empty the pockets:

Objects such as coins or lighters can damage the washing machine and the drum. Check all buttons.

Follow the dosage recommendation / additives

It optimizes the cleaning result, it avoids irritating residues of surplus detergent in your laundry and it saves money by avoiding waste of surplus detergent

Use low temperature and longer duration

The most efficient programmes in terms of energy consumption are generally those that perform at lower temperatures and longer duration.

Observe the load sizes

Load your washing machine up to the capacity indicated in the "PROGRAMME CHART" table to save water and energy.

Noise and remaining moisture content

They are influenced by the spinning speed: the higher the spinning speed in the spinning phase, the higher the noise and the lower the remaining moisture content.

CARE AND MAINTENANCE

Before performing cleaning and maintenance, switch the washing machine off and disconnect it from the mains power. Do not use flammable liquids to clean the washing machine. Clean and maintain your washer - dryer periodically (at least 4 times per year).

Disconnect the water and power supplies

Close the water tap after every wash. This will limit wear on the hydraulic system inside the washing machine and help to prevent leaks. Unplug the washing machine when cleaning it and during all maintenance work.

Clean the washing machine

The outer parts and rubber components of the appliance can be cleaned using a soft cloth soaked in lukewarm soapy water. Do not use solvents or abrasives.

Clean the detergent dispenser drawer

Wash it under running water; this operation should be repeated frequently.

Care for the door and drum

Always leave the porthole door ajar in order to prevent unpleasant odours from forming.

Check the water inlet hose

Check the water inlet hose at least once a year. If it is cracked or broken, it must be replaced: during wash cycles, the high pressure of the water could suddenly split the hose open.

! Never use hoses that have already been used.

Cleaning the water filter / draining residual water

Switch off and unplug the washing machine, take out the kitchen plinth before cleaning the water filter or draining residual water.

The kitchen plinth must be mounted back all the time once the cleaning operation is over.

If you used a hot wash programme, wait until the water has cooled down before draining any water. Clean the water filter regularly, to avoid that the water cannot drain after the wash due to obstruction of the filter. If the water cannot drain, the display indicates that the water filter may be clogged.

- 1 . Place a container close to the pump to collect any spillage.
- 2 . **Remove, pulling it out, the "emergency drain hose"** from the base of the washing machine .

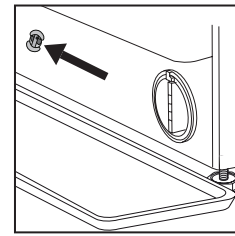

Remove the stopper of the "emergency drain hose" at the end of the hose and let the water flow into the container.

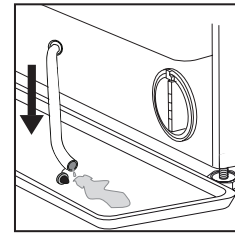

3 . Turn the exhaust filter handle and pull it out of the housing . When the container of plinth is full with water, plug the stopper to the hose end, and reinsert the small hose in the washing machine's base . After, empty the container .

Afterwards firmly close the emergency drain hose with the stopper .
4 . **Remove filter:** Lay a cotton cloth beneath the water filter, which can absorb a small amount of rest water . Then remove the water filter by turning it out anticlockwise .

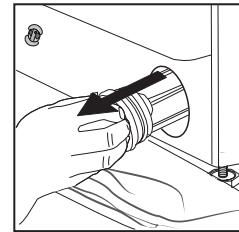
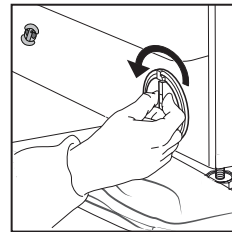

5 . Clean the water filter: remove residues in the filter and clean it under running water .

6 . Insert the water filter: Reinsert the water filter again by turning it in clockwise direction . Make sure to turn it in as far as it goes; the filter handle must be in vertical position . To test water tightness of the water filter, you can pour about 1 liter of water into the detergent dispenser .

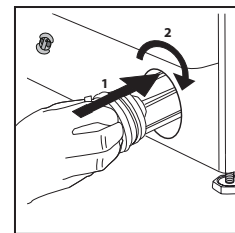

Then reinstall the kitchen plinth.

LOAD BALANCING SYSTEM





Before every spin cycle, to avoid excessive vibrations before every spin and to distribute the load in a uniform manner, the drum rotates continuously at a speed which is slightly greater than the washing rotation speed. If, after several attempts, the load is not balanced correctly, the machine spins at a reduced spin speed. If the load is excessively unbalanced, the washing machine performs the distribution process instead of spinning. To encourage improved load distribution and balance, we recommend small and large garments are mixed in the load.



TRANSPORT AND HANDLING

Do not lift the washing machine by gripping it from the upper section. Unplug the appliance and close the water tap. Check that the door and detergent dispenser drawer are tightly closed. Detach the filling hose from the water tap then detach the drain hose. Empty all the water remaining in the hoses and secure the latter so that they do not get damaged during transport. Apply the transport bolts back on. Repeat, in reverse order, the transport bolt removal procedure described in the "Health & Safety and Installation Guides".

TROUBLESHOOTING

The washing machine may occasionally fail to work. Before contacting the Technical Assistance Service, make sure that the problem cannot be easily solved using the following list.

Anomalies	Possible causes / Solution
The washing machine does not start.	The appliance is not plugged into the socket, or not sufficiently to make contact.
	There is no power in the house.
The wash cycle does not start.	The washing machine door is not closed properly.
	The ON/OFF  button has not been pressed.
	The START/PAUSE  button has not been pressed.
	The water tap has not been opened.
	A delay has been set for the start time.
The washing machine does not fill with water ("H2O" flashes on the display).	The water inlet hose is not connected to the tap.
	The hose is bent.
	The water tap has not been opened.
	There is no water supply in the house.
	The pressure is too low.
	The START/PAUSE  button has not been pressed.
The washing machine continuously loads and unloads water.	The drain hose is not fitted between 65 and 100 cm from the floor.
	The free end of the hose is immersed in water.
	The wall drainage system does not have a breather pipe.
	If the problem persists even after these checks, turn off the water tap, switch the appliance off and contact the Technical Assistance Service. If the home is on one of the upper floors of a building, there may be problems relating to back-siphonage, causing the washing machine to fill with water and drain continuously. Special anti-siphon valves are available in shops and help to prevent this inconvenience.
The washing machine does not drain or spin.	The cycle does not include drainage: with certain cycles it must be started manually.
	The drain hose is bent.
	The drainage duct is clogged.
The washing machine vibrates a lot during the spin cycle.	The drum was not unlocked correctly during installation.
	The washing machine is not level.
	The washing machine is tucked between furniture cabinets and the wall.
The washing machine leaks.	The water inlet hose is not screwed on properly.
	The detergent dispenser drawer is obstructed.
	The drain hose is not properly attached.
The "Options" and START/PAUSE  indicator lights flash rapidly and the display visualises an error code (e.g.: F-01, F-...).	Switch off the machine and unplug it, wait for approximately 1 minute and then switch it back on again. If the problem persists, contact the Technical Assistance Service .
There is too much foam.	The detergent is not suitable for machine washing (it should be marked with "for washing machine use" or "hand wash and machine wash" or similar).
	Too much detergent was used.
The washer-dryer does not dry.	The appliance is not plugged into the socket, or not enough to make contact.
	There has been a power failure.
	The appliance door is not shut properly.
	A DELAY TIMER has been set.
	DRYING is in the OFF position.

DEMO MODE: to deactivate this function, switch the washing machine OFF. Then press and hold "Start/Pause"  button, within 5 seconds press also "ON/OFF"  button and hold both buttons for 2 seconds.



You can download the Safety Instructions, Product Fiche and Energy data by:

- Visiting our website - <http://docs.whirlpool.eu>
- Using QR Code
- Alternatively, **contact our After-sales Service** (See phone number in the warranty booklet). When contacting our After-sales Service, please state the codes provided on your product's identification plate. For User's Repair & Maintenance Information visit www.whirlpool.eu

